

Carbon Road Stem Installation Instructions

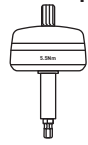

Tools Needed:

4mm Torque
Wrench (5.5Nm)



5mm Allen Key

1.

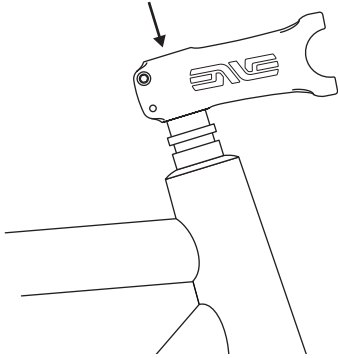

2.

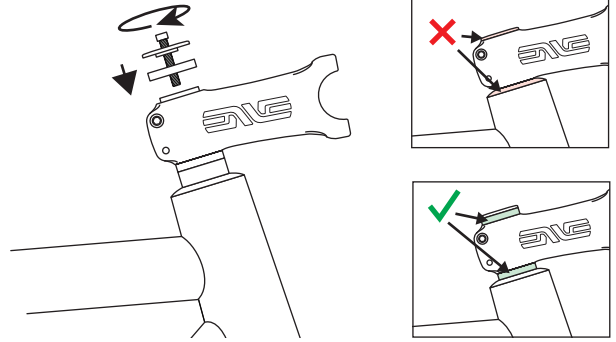

3.

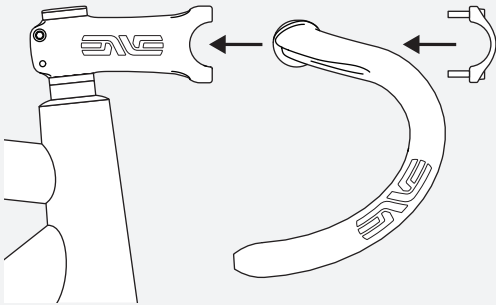

4.

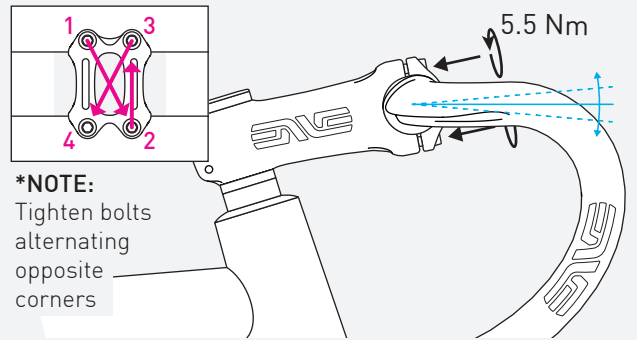

5.

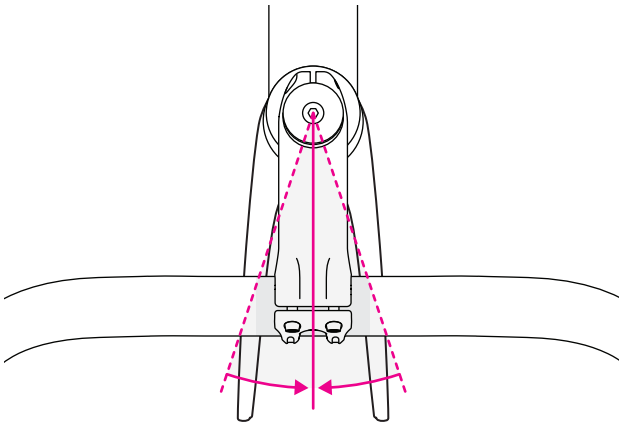

6.

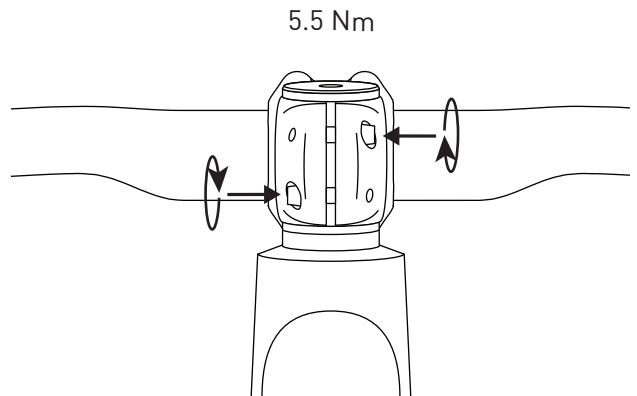



**ENVE Carbon Road Stem
Installation Instructions**

ENVE Composites, LLC
Ogden, UT 84401, USA